

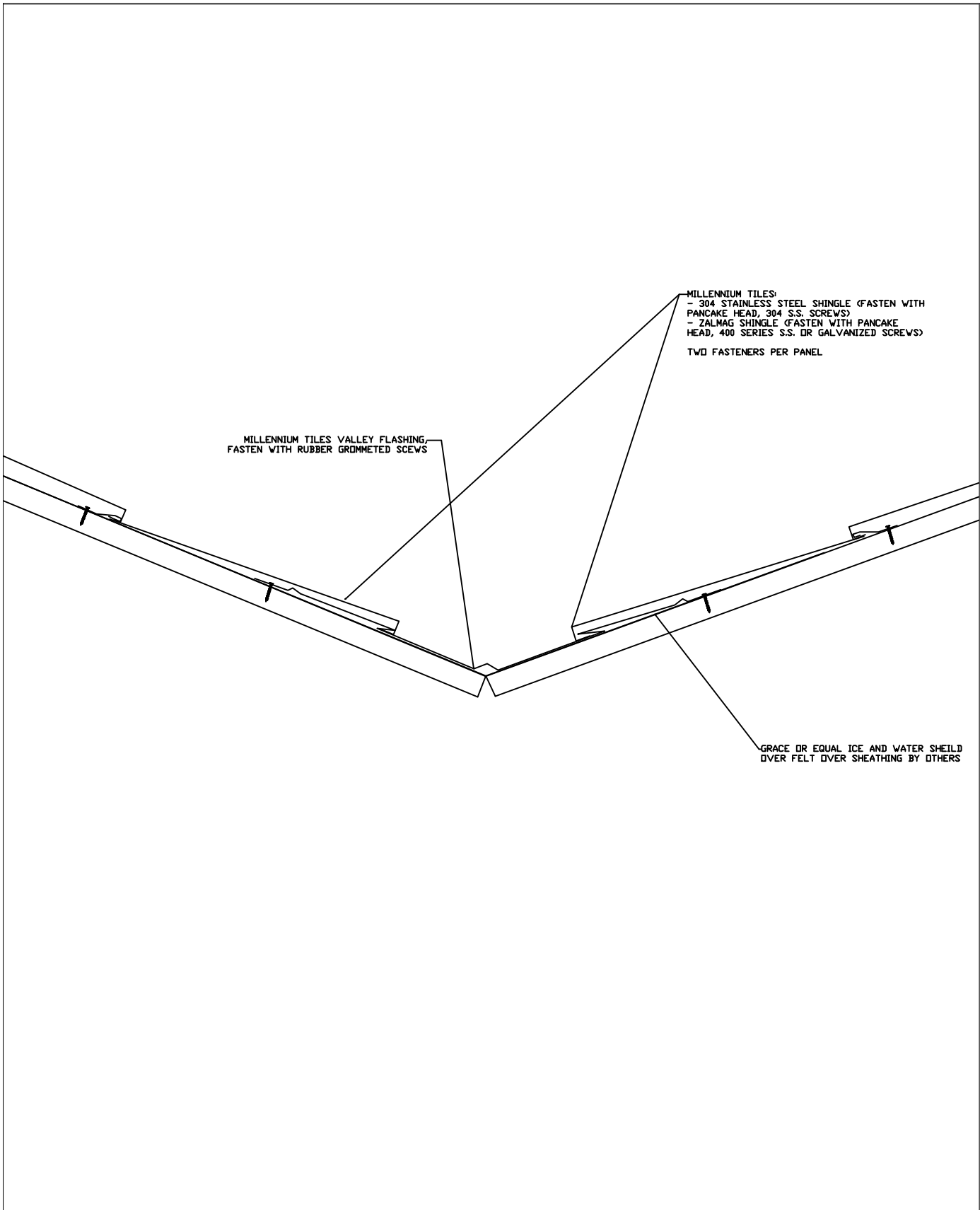

Roof Tiles - Reference Diagram

 <p>MILLENNIUM FORMS</p> <p><small>*The physics of Light Interference Color (LIC) prevent colored stainless steel from being 100% uniform</small></p>	<p>*STAINLESS COLORS</p> <p>NATURAL, PEWTER, WHEAT, BRONZE, BLUE, SLATE, BRONZE-GOLD, BURGUNDY, PURPLE-BLUE, PEACOCK, BLUE-GREEN, CHARCOAL (#4-SCOTCHBRITE FINISH ONLY)</p>	<p>GA. AVAILABLE</p> <p>28 GAUGE (.018")</p>	<p>MATERIALS</p> <p>STAINLESS STEEL + ZALMAG®</p>	<p>FINISH</p> <p>STAINLESS: BRIGHT (BA), MILL (2B) ZALMAG: NATURAL & PRE-PATINA II</p>
			<p>SIZES AVAILABLE</p> <p>10' Standard Length</p>	



Diamond Tile

Roof Tiles - Roof Valley

	*STAINLESS COLORS	GA. AVAILABLE	MATERIALS	FINISH
 MILLENNIUM F O R M S <small>*The physics of Light Interference Color (LIC) prevent colored stainless steel from being 100% uniform</small>	NATURAL, PEWTER, WHEAT, BRONZE, BLUE, SLATE, BRONZE-GOLD, BURGUNDY, PURPLE-BLUE, PEACOCK, BLUE-GREEN, CHARCOAL (#4/SCOTCHBRITE FINISH ONLY)	28 GAUGE (.016")	STAINLESS STEEL + ZALMAG®	STAINLESS: BRIGHT (BA), MILL (2B) ZALMAG: NATURAL & PRE-PATINA II
			SIZES AVAILABLE	
			16' Standard Length	

DETAIL

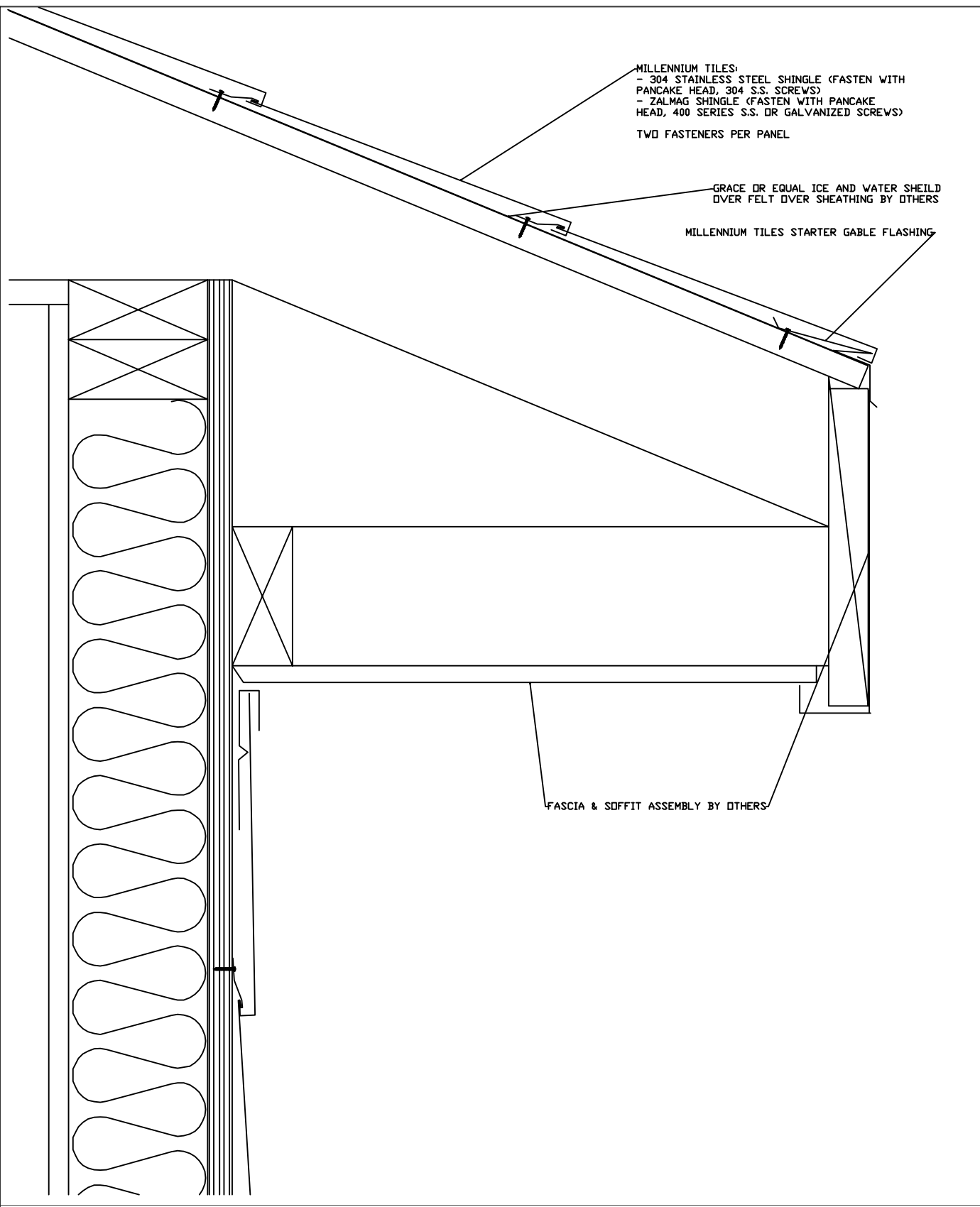

Roof Tiles

Roof Tiles - Roof Eave

 MILLENNIUM FORMS <small>*The physics of Light Interference Color (LIC) prevent colored stainless steel from being 100% uniform</small>	*STAINLESS COLORS NATURAL, PEWTER, WHEAT, BRONZE, BLUE, SLATE, BRONZE-GOLD, BURGUNDY, PURPLE-BLUE, PEACOCK, BLUE-GREEN, CHARCOAL (4-BLACKBRITE FINISH ONLY)	GA. AVAILABLE 28 GAUGE (.018")	MATERIALS STAINLESS STEEL + ZALMAG®	FINISH STAINLESS: BRIGHT (BA), MILL (2B) ZALMAG: NATURAL & PRE-PATINA II	DETAIL 2
			SIZES AVAILABLE 10' Standard Length		

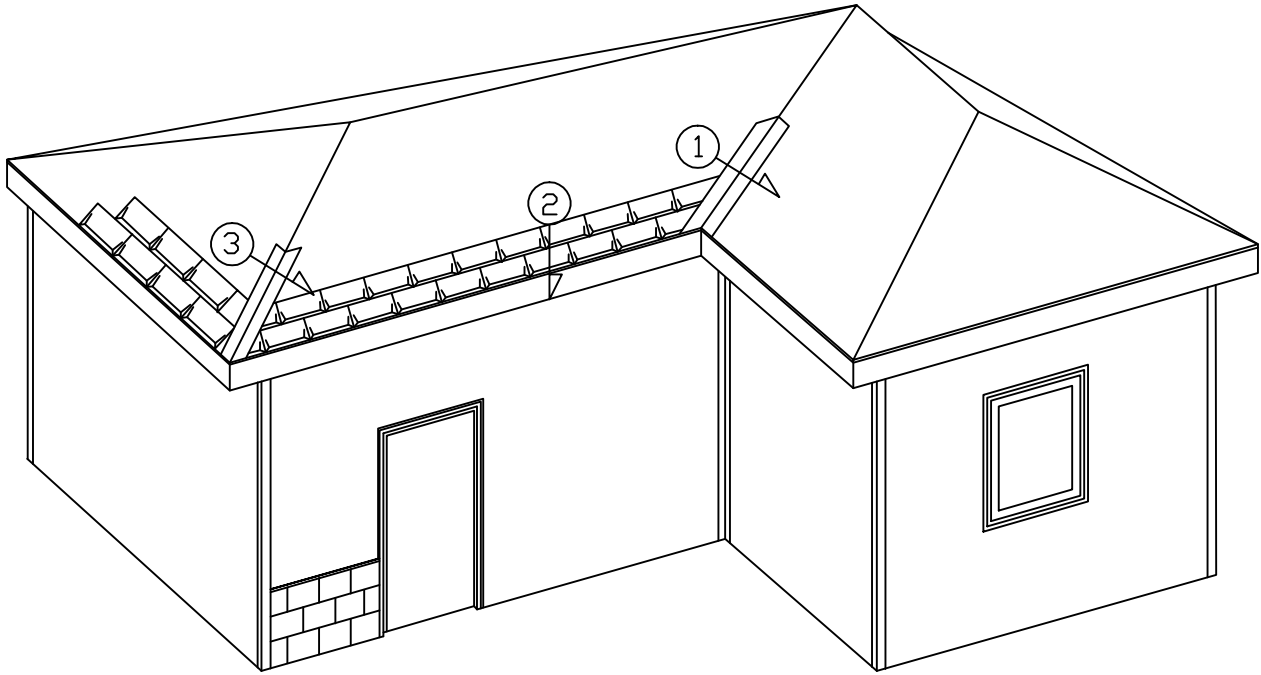

COMING SOON!

Roof Tiles - Roof Ridge or Hip

 <p>MILLENNIUM FORMS</p> <p><small>*The physics of Light Interference Color (LIC) prevent colored stainless steel from being 100% uniform</small></p>	<p>*STAINLESS COLORS</p> <p>NATURAL, PEWTER, WHEAT, BRONZE, BLUE, SLATE, BRONZE-GOLD, BURGUNDY, PURPLE-BLUE, PEACOCK, BLUE-GREEN, CHARCOAL (#14 SCOTCHBRITE FINISH ONLY)</p>	<p>GA. AVAILABLE</p> <p>28 GAUGE (.018")</p>	<p>MATERIALS</p> <p>STAINLESS STEEL + ZALMAG®</p>	<p>FINISH</p> <p>STAINLESS: BRIGHT (BA), MILL (2B) ZALMAG: NATURAL & PRE-PATINA II</p>
			<p>SIZES AVAILABLE</p> <p>10' Standard Length</p>	

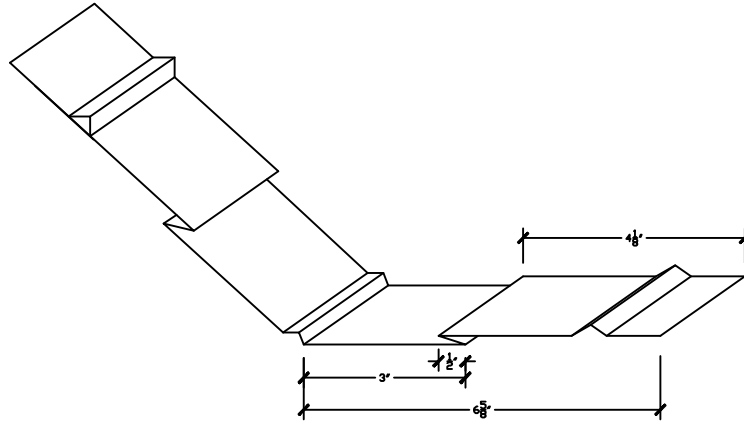

1 TYPICAL VALLEY
15 1/4" WIDE SHEET STOCK BEFORE FOLDS

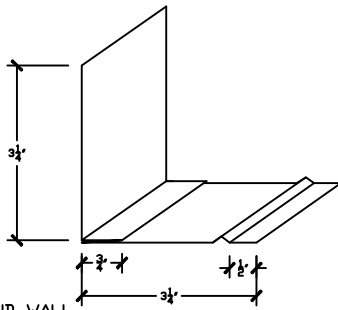

2 TYPICAL END WALL
8" WIDE SHEET STOCK BEFORE FOLDS

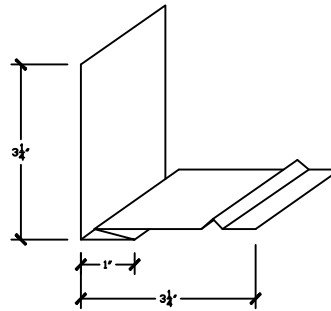

3 TYPICAL SIDE WALL
8" WIDE SHEET STOCK BEFORE FOLDS

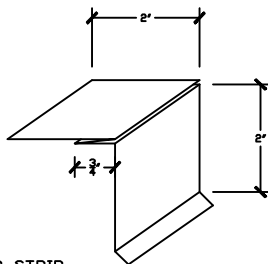

4 TYPICAL STARTER STRIP
5 1/2" WIDE SHEET STOCK BEFORE FOLDS

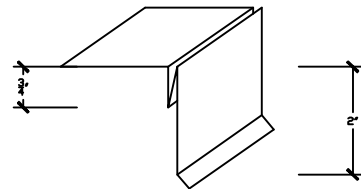

5 TYPICAL GABLE END
5-1/2" WIDE SHEET STOCK BEFORE FOLDS

Typical Roof Flashing Details

 <p>MILLENNIUM FORMS</p> <p><small>*The physics of Light Interference Color (LIC) prevent colored stainless steel from being 100% uniform</small></p>	<p>*STAINLESS COLORS</p> <p>NATURAL, PEWTER, WHEAT, BRONZE, BLUE, SLATE, BRONZE-GOLD, BURGUNDY, PURPLE-BLUE, PEACOCK, BLUE-GREEN, CHARCOAL (4-BLACHTONITE FINISH ONLY)</p>	<p>GA. AVAILABLE</p> <p>28 GAUGE (.018")</p>	<p>MATERIALS</p> <p>STAINLESS STEEL + ZALMAG®</p>	<p>FINISH</p> <p>STAINLESS: BRIGHT (BA), MILL (2B) ZALMAG: NATURAL & PRE-PATINA II</p>	
			<p>SIZES AVAILABLE</p> <p>10' Standard Length</p>		